



User Guide Standards

**2.9" ePaper Display (EA2220-
BJC)**



Table of Contents

Firmware Update SOP	1
1 Hardware Guide	1
(1) Hardware Requirements.....	1
(2) Hardware Installation	1
2 Software Guide.....	3
(1) Software Requirements	3
(2) Firmware Update by Application Software	4
ePaper Display Update SOP	6
1 Introduction	6
(1) Package Contents.....	7
2 Hardware Guide	8
(1) Hardware RequiRements.....	8
(2) Demo Kit Hardware Description	9
(3) Hardware Installation	10
3 Software Guide.....	13
(1) Demo Kit Connection.....	13
(2) Update Initial Data.....	13
(3) Uploading Image.....	14
4 Troubleshooting	15
5 Contact Information	15
6 Legal Information	15

Firmware Update SOP

1 Hardware Guide

(1) Hardware Requirements

Buy a set of MSP-EXP430G2 from Digi-Key

You will get following stuffs in the package

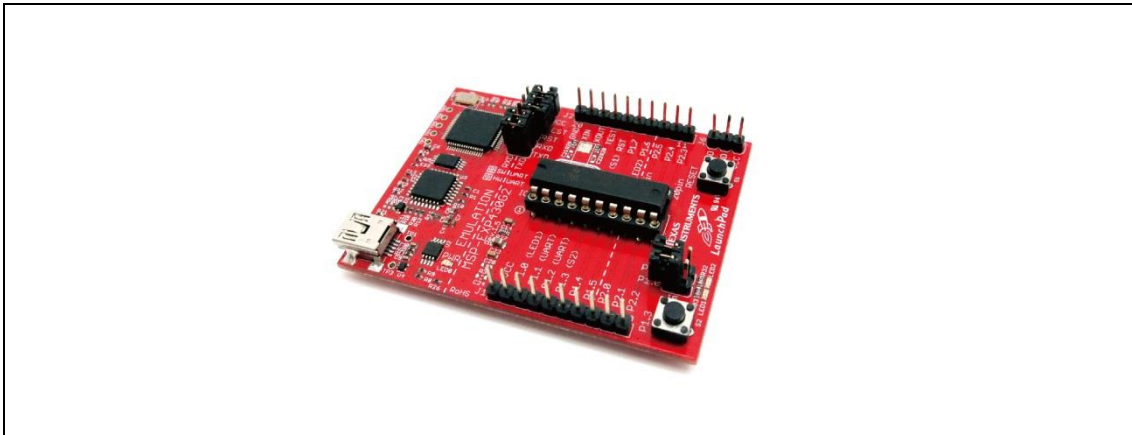

MSP-EXP430G2

(2) Hardware Installation

The programmer need the jump line as the picture below

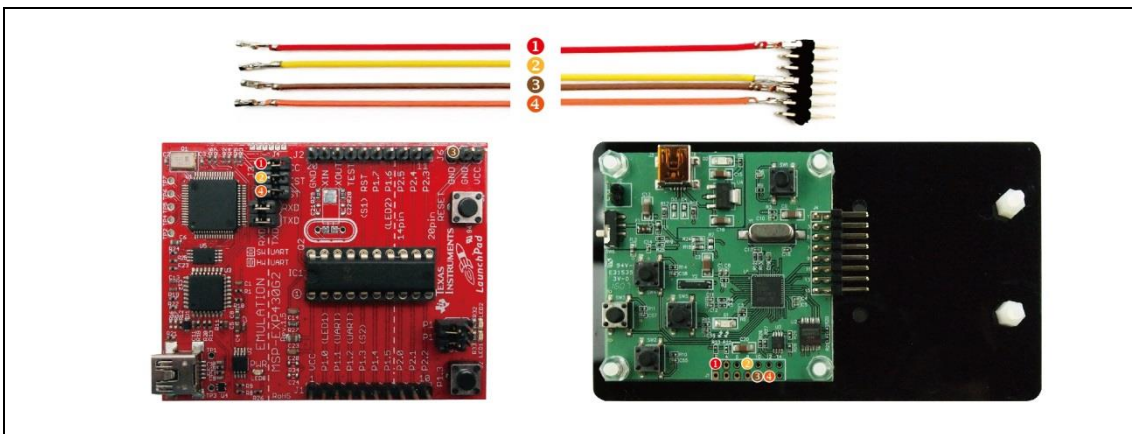

Connect to MSP430 and HULK MCU board

- Please connect the Dupont line from J3 (VCC pin) of MSP430 LaunchPad to J1's 2nd pin of HULK
- Please connect the Dupont line from J3 (TEST pin) of MSP430 LaunchPad to J1's 8th

pin of HULK

- Please connect the Dupont line from J3 (RST pin) of MSP430 LaunchPad to J1's 11th pin of HULK
- Please connect the Dupont line from J6 (GND pin) of MSP430 LaunchPad to J1's 9th pin of HULK

Please pay attention! It must remove the HULK's adapter board when updating Firmware.

When you update Firmware, please confirm if the D2(power indicator) or D2(power indicator) and D1(data indicator) of HULK are lighted.

- It can update Firmware when indicators are lighted.
- If the indicators are not lighted, please confirm the connect again.

Refer to following figure to setup MSP-EXP430G2 and connect it to your PC

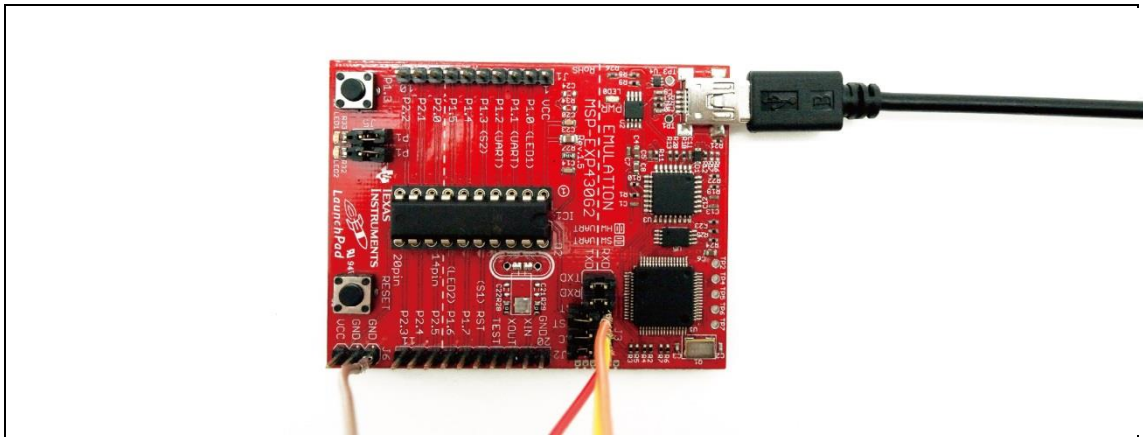



Connect to PC

2 Software Guide

(1) Software Requirements

Refer the guideline in following FET-Pro430 Lite website to download and setup driver of MSP-EXP430G2

<https://www.elprotronic.com/pages/downloads>

FET-Pro-430	
Inst. package for FET-Pro-430, includes GUI, DLL, and supporting material. Standard. V3.51 (TI-DLL V3.14.00.00) (21.Jun.2019)	
Inst. package for FET-Pro-430-LITE, includes GUI, and supporting material. Lite. V3.51 (TI-DLL V3.14.00.00) (21.Jun.2019)	

Refer to following figure to connect MSP-EXP430G2 with your PC and HULK together.

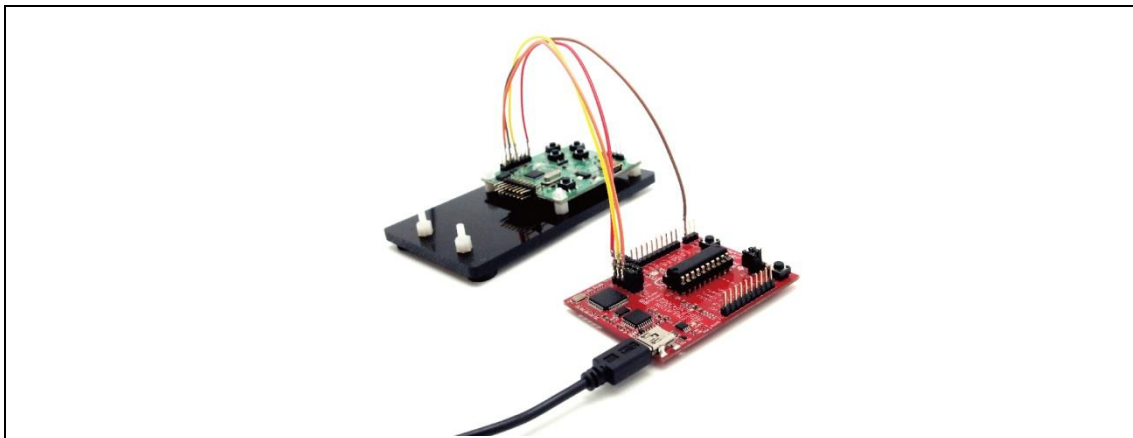

Connect to PC

(2) Firmware Update by Application Software

Press drop-down menu "Microcontroller Type" to select a MCU model MSP430F5502

Please check "Port USB Automatic" to select 4-wires

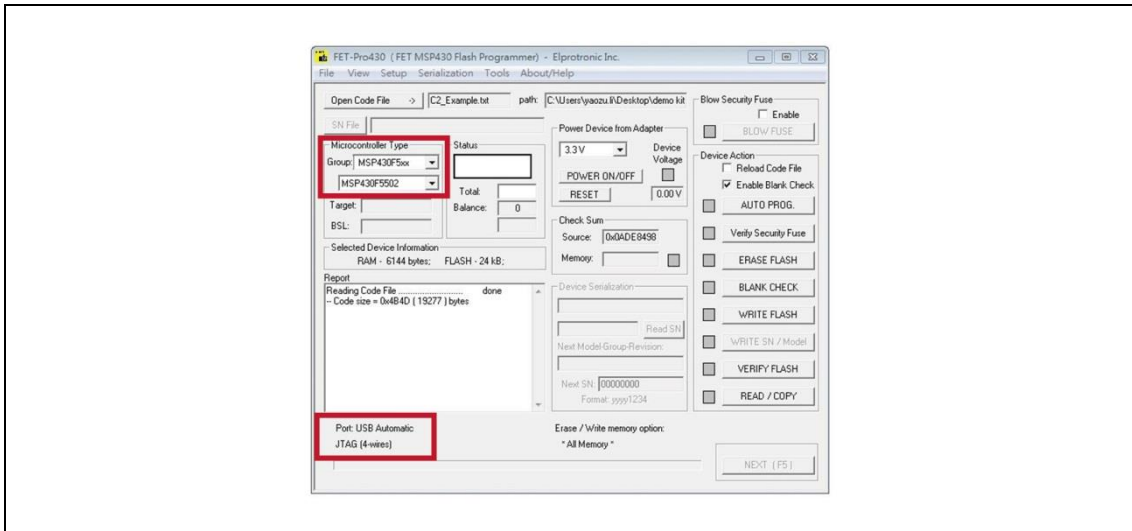

Press "Open code file" button to select a firmware file (.txt)

Press "AUTO PROG" button to update the firmware into MCU

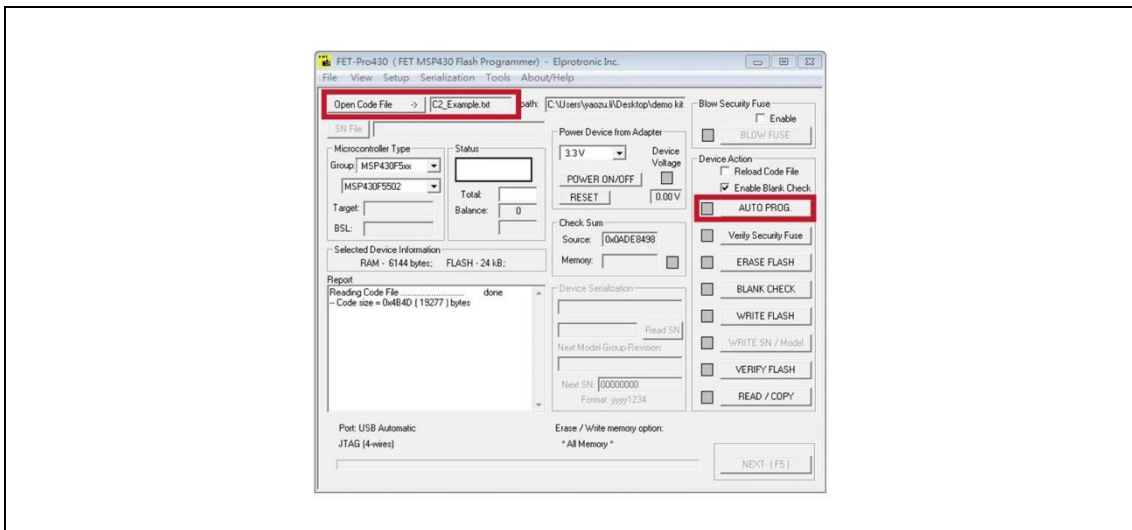

Show the Pass is firmware update ok.

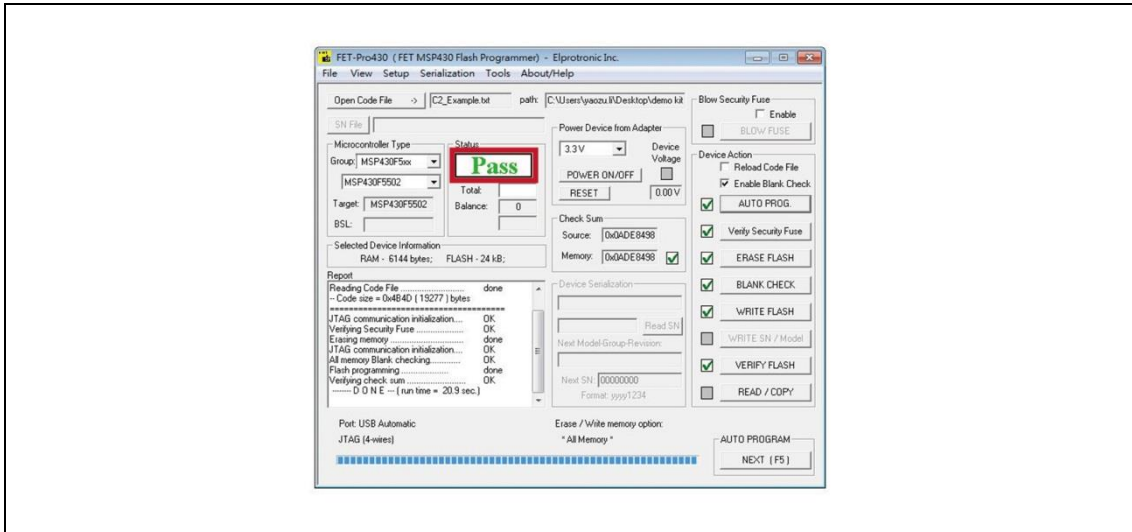

ePaper Display Update SOP

1 Introduction

HULK - demo kit, with 2.9" e-Paper display (EPD) - EA2220-BJC, allows E Ink clients to access hardware and software for evaluation. This kit demonstrates as a turnkey solution for those who are interested in designing with E Ink displays. Hardware and software design support is available from E Ink directly.

2.9" EPD is suitable for various applications, e.g. Electronic shelf labels

The low power consumption of the EA2220-BJC is ideal for applications such as electronic shelf labels and indicators.

An All-in-one IC is embedded in the EPD, it include source/gate driver, TCON (Timing controller), PMIC(power management IC) and Temp. sensor. It allows users to rapidly design systems by using E Ink displays.

The kit allows E Ink clients to experience loading and viewing custom images on 2.9" EPD. The use of MCU board to drive an E Ink EPD is demonstrated with the kit.

IAR Integrated Development Environment (IDE) is adopted to write, download, and debug an application.

(1) Package Contents

This demo kit contains the following:

- E Ink demo kit: MCU driving board and E Ink display adapter
- 2.9" EPD
- Mini USB cable



Demo Kit Contents

Specification

Item	Specification
MCU	MSP430
TCON Solution	Hardware TCON
E Ink Display Panel	
Dimension (W × H × D, unit: mm)	36.7(W) × 79.0(H) × 1.15(D) (W/PF)
Shape	Square
Resolution	296(H) × 128(V),
Controller Board	
Input	5V(USB), power on when connected to PC

2 Hardware Guide

(1) Hardware Requirements



MCU board and display adapter



EPD panel



Mini USB cable



Windows PC

Minimum PC Requirements

CPU	Pentium III 800 MHz or later
RAM	128MB or greater
Required Software	Windows XP
Interface	USB port

(2) Demo Kit Hardware Description

The HULK_2.9" demo Kit includes an MCU board and an E Ink display adapter board. The MCU board and E Ink display adapter board are connected via a 16 pin header. The mini USB port on the demo kit supplies data and power to the MCU board and E Ink panel. Using the E Ink PC application, users can send image data to the board or update settings.

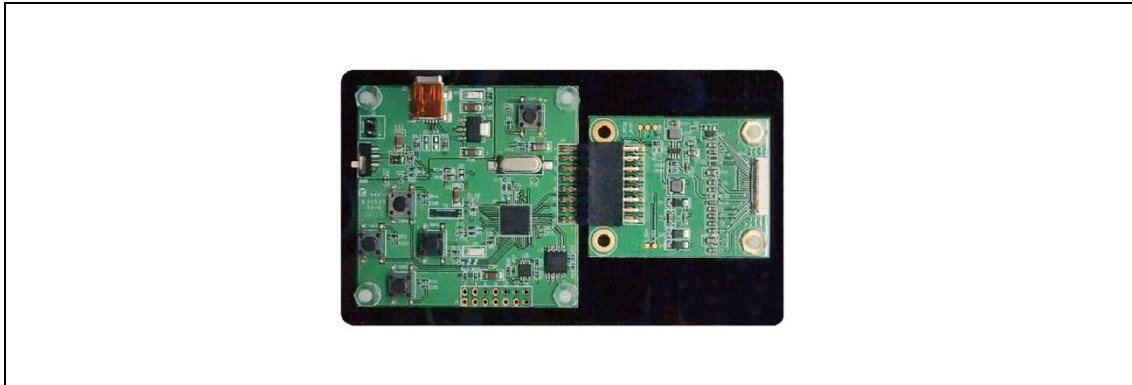

Demo Kit

There are two LEDs on the MCU board, LED 1 and LED 2. LED 1 indicates the board is powered. LED 2 is used as a multi-purpose function light

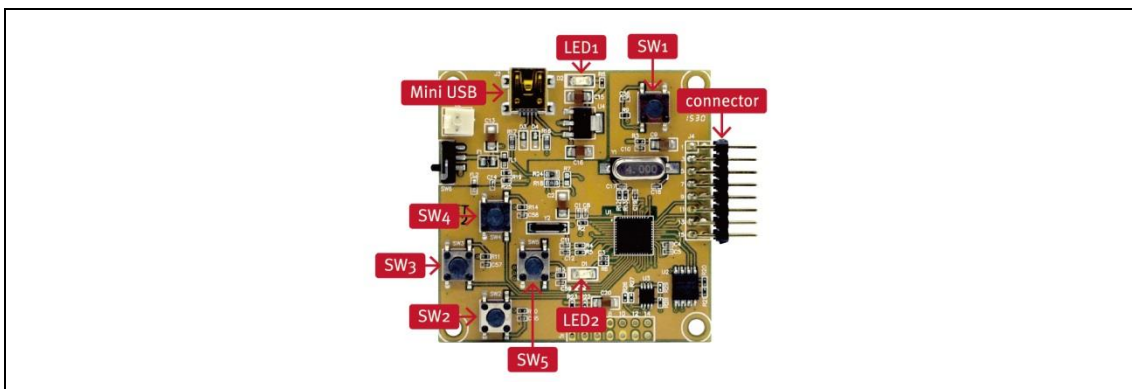

MCU Board for Demo Kit

* When LED2 is light on, EPD can't accept any command

Four push button switches are also on the MCU board. The table below provides a short description of the functions for each button.

Description of button functions

Button	Function
SW1	Reset
SW2	Display NEXT image
SW3	NA
SW4	NA
SW5	White/Black/Red image

(3) Hardware Installation

The HULK_2.9" demo kit is connected to a PC via a mini USB cable. The PC requires a USB driver to be installed on the PC.

Connect one end of the mini-USB cable to the HULK_2.9" demo kit and other end to a USB port on a PC.

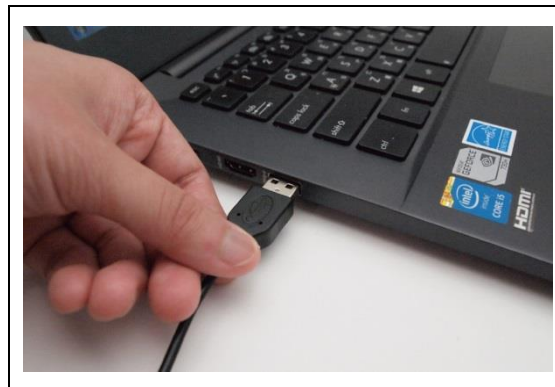
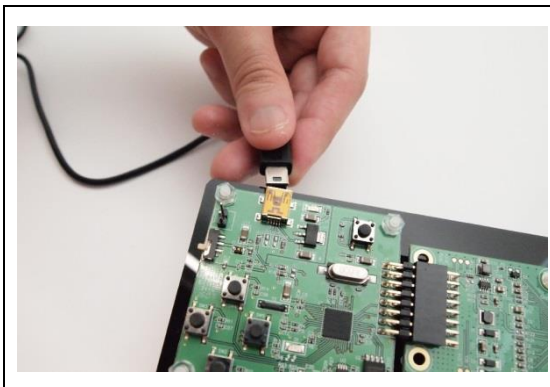

Open Device Manager on the computer. A new device called **MSP430-USB Example** should be in the list. If this is the first time setting up the hardware, installation of the device driver is required.

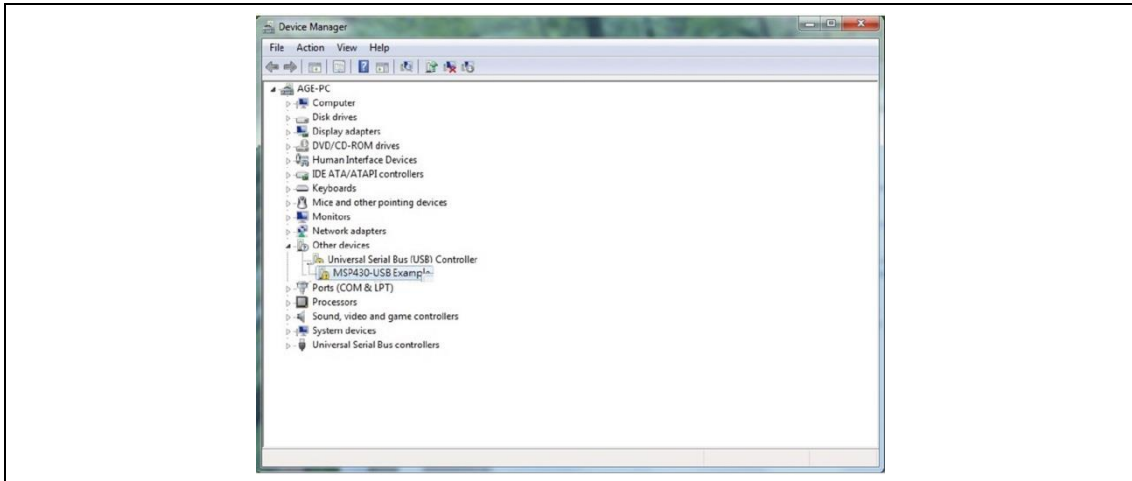

To install the device driver for **MSP430-USB Example**, double click on the device to bring up the device Window. Click on "Update Driver" and select the file "HULK-USB-Driver.inf".

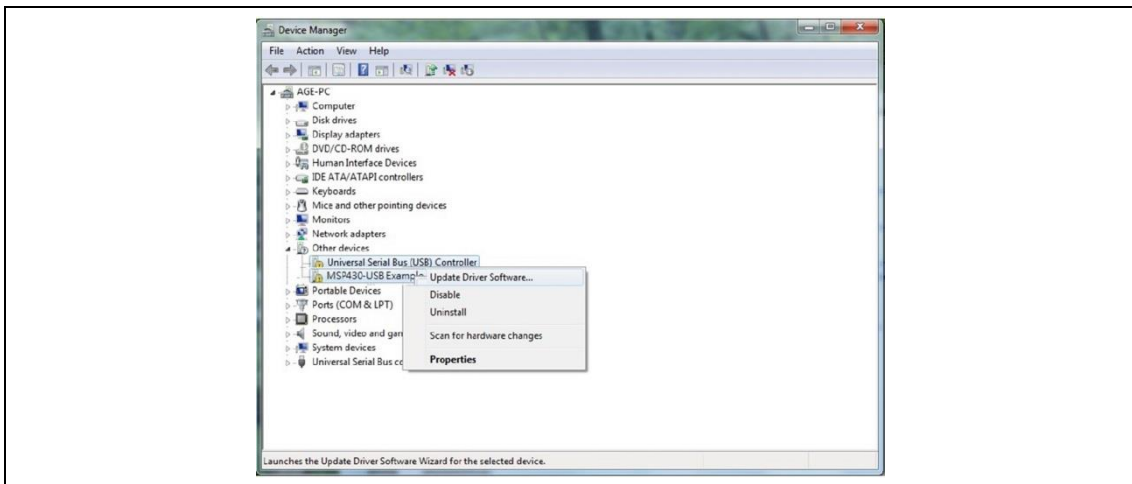

* This driver has been tested on Windows 7 64-bits

To verify the installation of the driver was successful, a new device called **Virtual COM Port (CDC)** should be present under **COM LPT**.

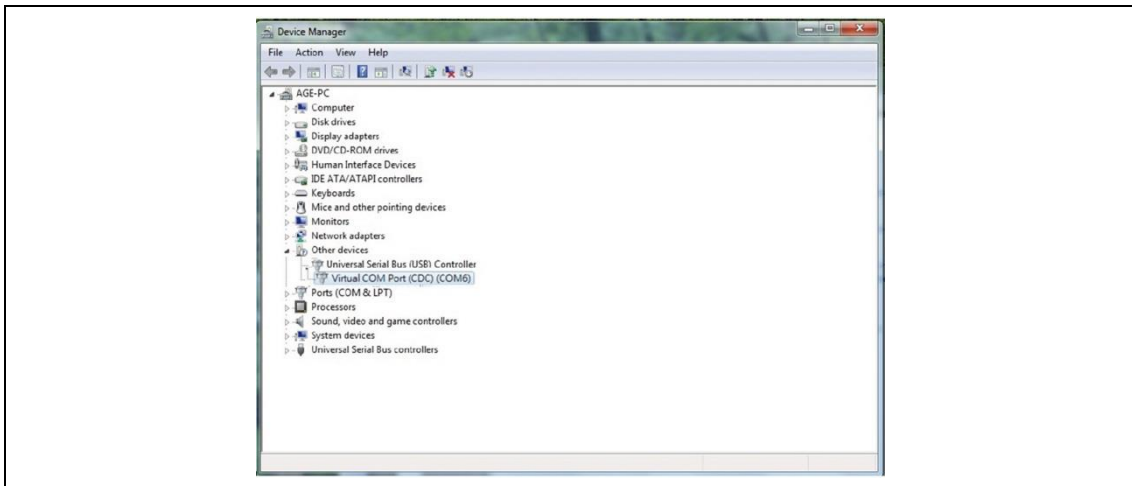

3 Software Guide

(1) Demo Kit Connection

- Open Flash_Burner.exe
- If connection is correct, the COM port number will show up.
- Select the COM port and press "connect"

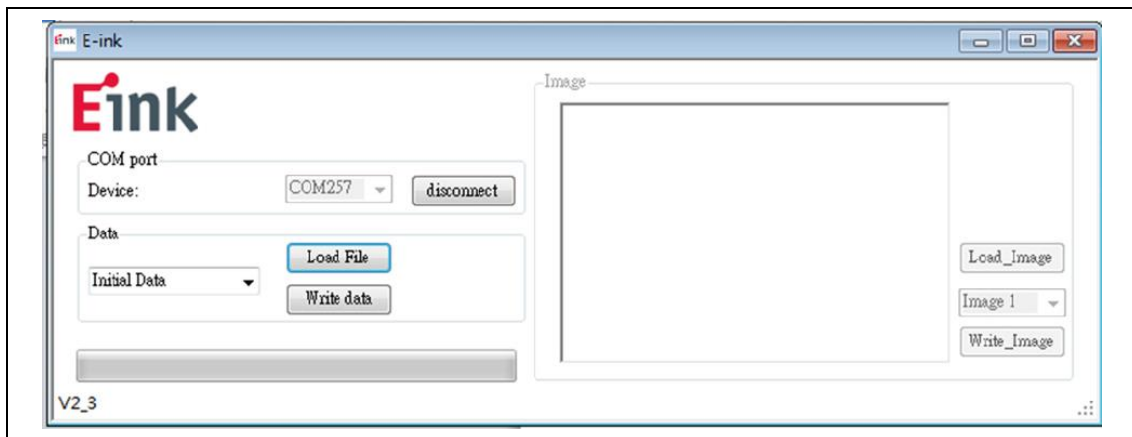

- * If connection is incorrect, the COM port will show COM1~COM6 (Please check driver for the EVK)

(2) Update Initial Data

- Select "Initial Data"
- Press "Load file" to select a Initial file (.eink) that you want to use for the EPD.
- Press "Write data" to update Initial file into the kit

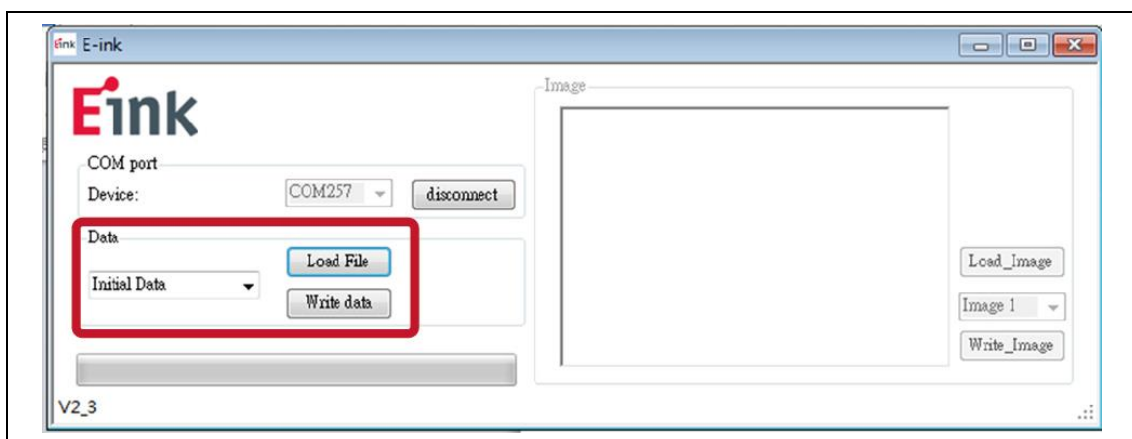

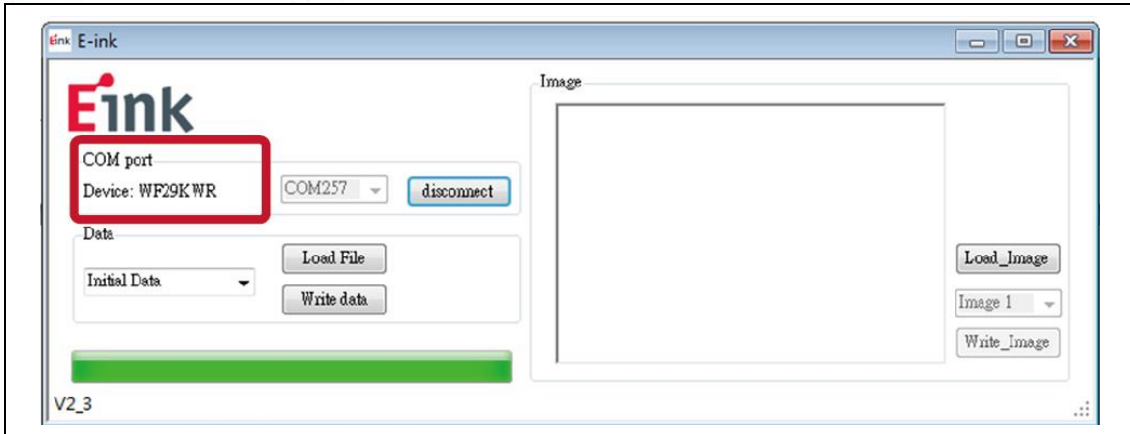

- * After Initial Data are updated, you should press "disconnect" and un-plug/plug Mini USB to restart the kit. If update is successful, the device name will show up

(3) Uploading Image

- Press "Load_Image" to select a image
- Select "image 1" ~ "image 2" to decide display sequence
- Press "Write_Image" to update image into the kit



- * After all image are updated, you should press "disconnect" and un-plug/ plug Mini USB to restart the kit.

4 Troubleshooting

Below lists commonly asked questions.

Num	Name	Description
1	HULK_2.9" demo kit is not detected by the PC	Cause: USB cable is damaged
		Solution: Replace the USB cable
2	Demo kit connection fails	Cause: Progress bar is not completed
		Solution: Disconnect the demo kit from Mini USB and restart Flash_Burner_for_2.9.exe
		Cause: USB cable is damaged

5 Contact Information

For more information, please visit

<http://www.eink.com>

For sales office addresses, please visit

http://www.eink.com/contact_sales.html

6 Legal Information

● Definitions

The document is a draft version only. The content is still under internal review and subject to formal approval which may result in modifications or additions. E Ink does not give any representations or warranties as to the accuracy or completeness of information included herein and shall have no liability for the consequences of use of such information.

● Right to make changes

E Ink reserves the right to make changes to information published in this document, including without limitation specifications and product descriptions, at any time and without notice.

● Suitability for use

Products described in this document are intended for development purposes only and comes without any warranty. E Ink accepts no liability for inclusion and/or use of E Ink

products in commercial products or applications and therefore such inclusion and/or use is at the customer's own risk. In no event shall E Ink be liable for any direct, indirect, incidental, special, exemplary, or consequential damages (including, but not limited to, procurement of substitute goods or services; loss of use, data, or profits; or business interruption) however caused and on any theory of liability, arising in any way out of the use of the software.

- Applications

Applications that are described herein for any of these products are for illustrative purposes only. E Ink makes no representation or warranty that such applications will be suitable for the specified use without further testing or modification.

- No offer to sell or license

Nothing in this document may be interpreted or construed as an offer to sell products that is open for acceptance or the grant, conveyance or implication of any license under any copyrights, patents or other industrial or intellectual property rights.

- Trademarks

Notice: All referenced brands, product names, service names, and trademarks are the property of their respective owners.

- Revision History

Version	Date	Pag	Description	Author
0.1	2016/12/27		Initial	Yaozu
0.2	2018/05/25		button functions	Jimmy